

Article number: 2031100M16150B2U

Description: E+G levelling foot  
GN 31-100-M16-150-B2-U

Note: U Without nut, Hexagon socket at the top, Wrench flat at the bottom

## Measures

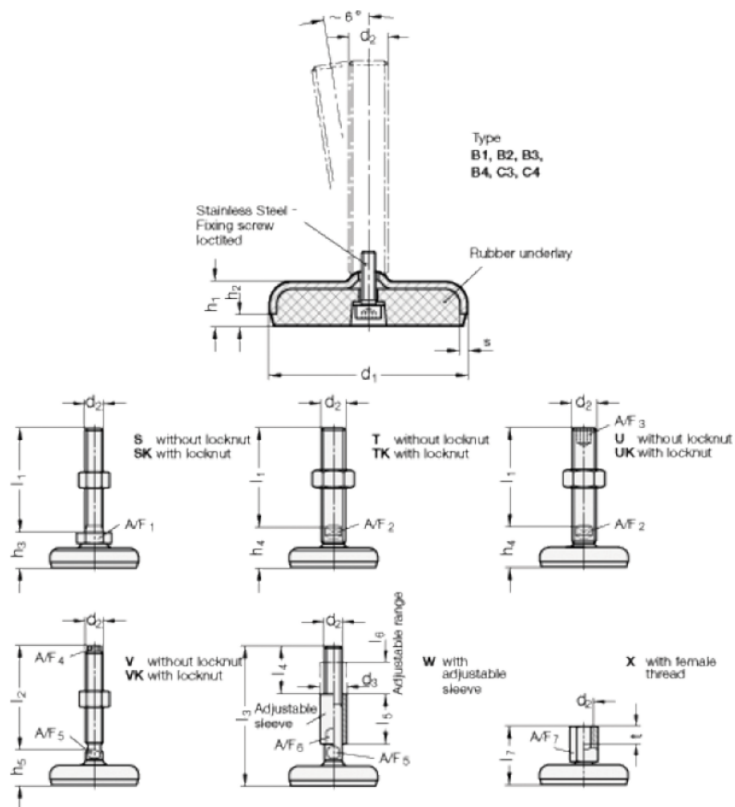

A/F2	= 12	s = 3
A/F3	= 8	
d1	= 100	
d2	= 16	
h1	= 20	
h2	= 6	
h4 +4.0/0	= 34	
l1	= 150	